

AgieCharmilles

LASER S

1000 U

1200 U

2500 U

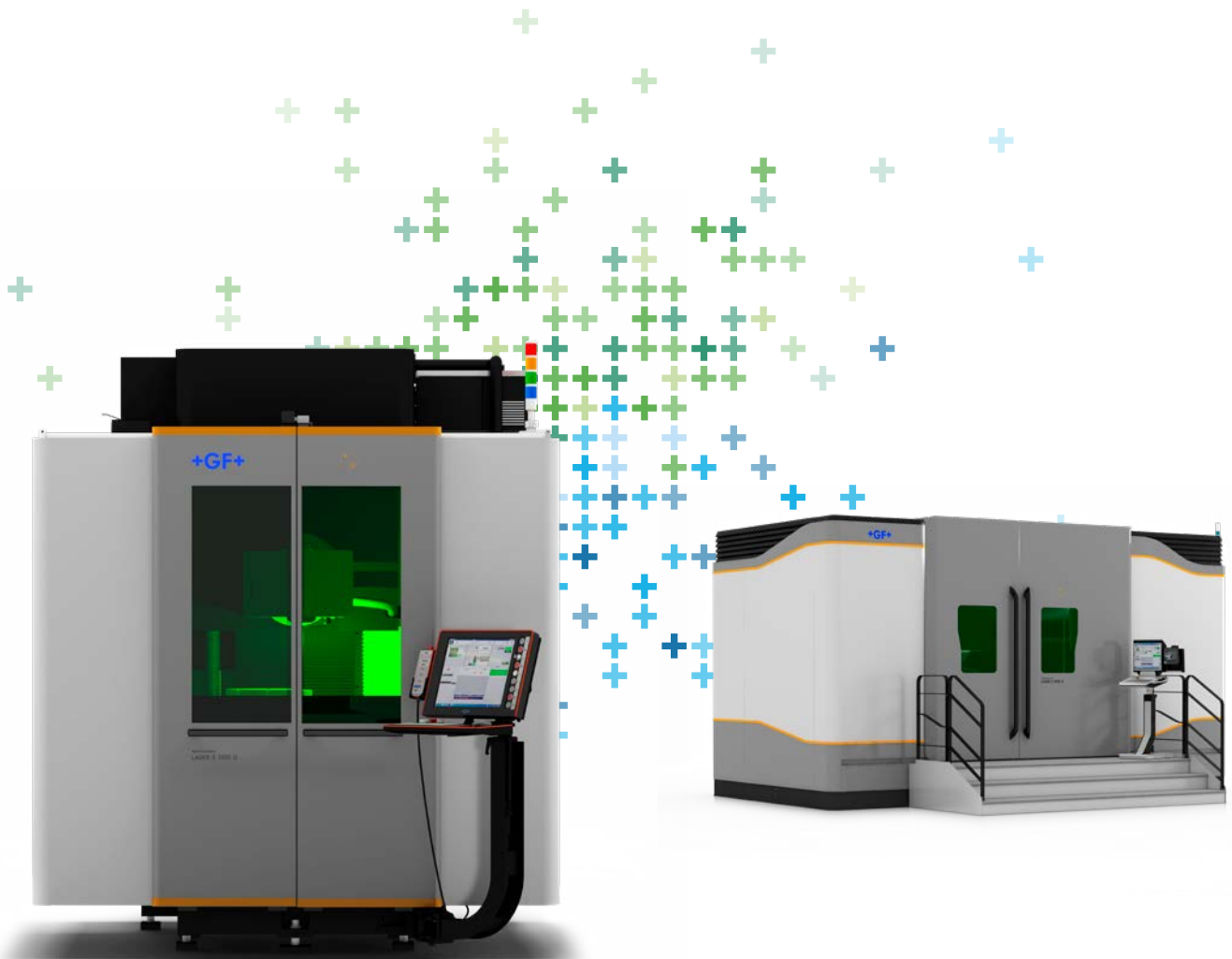

Becoming better every day – since 1802

GF Machining Solutions

When all you need is everything, it's good to know that there is one company that you can count on to deliver complete solutions and services. From unmatched Electrical Discharge Machining (EDM), Laser texturing, Laser micromachining, Additive Manufacturing and first-class Milling and Spindles to Tooling and Automation, all of our solutions are backed by unrivaled customer service and expert GF Machining Solutions training. Our AgieCharmilles, Microlution, Mikron Mill, Liechti, Step-Tec and System 3R technologies help you raise your game—and our digital business solutions for intelligent manufacturing, offering embedded expertise and optimized production processes across all industries, increase your competitive edge.



+ We are AgieCharmilles.
We are GF Machining Solutions.

Contents

4 A new manufacturing era begins

6 Our Laser solutions for you

8 LASER S series

10 Revolutionary surface texturing

12 Preparing the digital file

14 Smartpatch

16 The multi-process solution to drive your success

18 Mechanical innovative concept

20 Innovations at a controlled cost per part

22 High-speed 3D scanning system

25 Automation solutions

26 The partner of choice

28 Automotive lighting

29 Packaging closures

30 ICT device covers

32 Services and training

32 Academy

33 New digital service possibilities

35 Technical specifications

38 About GF Machining Solutions

A new manufacturing era begins

Aligned with GF Machining Solutions' vision of the smart factory of the future, our Laser texturing technology helps you overcome your daily manufacturing challenges while allowing you to innovate without compromise, speed up your time to market, and reduce your environmental impact.



Work digitally: Answer your manufacturing challenges

Digital transformation is underway and Laser texturing overcomes the limitations of manual and traditional methods to drive your surface texturing transformation. Defeat the daily challenges of difficult-to-realize designs and quality deviations, and tackle functional surfaces in order to seize new business opportunities. We understand your concerns: Our Laser texturing technology helps you keep pace in an ever-changing manufacturing world.

Innovate without compromise

Say goodbye to conventional manufacturing limitations with a solution developed to reduce your technical and economic constraints. Be ready to propose new product designs with fewer limitations, and innovate with confidence as a more efficient technology is now able to reduce the cost-per-part gap between existing technologies while delivering higher quality. Experience a technology that eliminates guesswork in executing your distinct designs—even on complex 3D surfaces—and achieve the expected optimal results.

Achieve faster time to market with less environmental impact

Time to market is key: You need to shorten your manufacturing chain while speeding it up in order to get your innovations to market faster. Laser texturing technology gives you access to the texturing operations essential to shortening your lead time by efficiently producing your textures internally.

Environmental sustainability is a major issue today and beyond, so governments are pushing chemical etchers to quickly adopt cleaner processes. GF Machining Solutions is committed to reducing its technologies' environmental impact, as demonstrated by our Laser texturing technology's cleaner, more efficient production of textured products. Laser texturing avoids the need for environment-polluting traditional methods that limit your design potential. Bet on a future technology right now.



Avoid chemical etching challenges

Today, manufacturers relying on conventional texturing methods like manual chemical etching face significant limitations with regard to design, including the high risk of errors, environmental challenges related to the use of acids, and difficulties in accurately texturing complex 3D shapes.

Work digitally



1. Import your 3D model

Work digitally: Import your 3D shape into the all-in-one software package to determine—with precision—the right position of the Laser operation that you would like to execute.

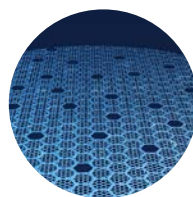

2. Develop new textures without limitations

Work with gray scale textures without design limitations. Create original textures in-house and from natural surfaces by reverse engineering via 3D scanner. Let your textures express your imagination.



3. Precisely apply your textures

Our software eliminates the guesswork, allowing our Laser products to recreate your distinct designs on large and complex surfaces, ensuring quality and precision. Manual tasks are reduced to the minimum.



4. Machine your design in a single setup

Catch additional market opportunities with a versatile solution: Realize engraving, marking and texturing operations, all with the same machine, thanks to the all-in-one software package. Your design is perfectly repeated.

Our Laser solutions for you

GF Machining Solutions' digital Laser texturing technology—fully digital, precise and ecologically sound—is already a proven solution for adding distinct textures to molds for car interiors, packaging, home appliances and ICT. Today, it is poised to transform the texturing of plastic injection molds and allow designers to innovate without limits thanks to our unique Laser texturing product portfolio answering your specific needs.



Performance line

The AgieCharmilles LASER P series, available since 2009, has become the market's reference for Laser texturing. LASER P users enjoy the full range of Laser texturing advantages and the big plus of controlled costs. Be ready to seize new business opportunities with lucrative applications enabled by the AgieCharmilles LASER P series.

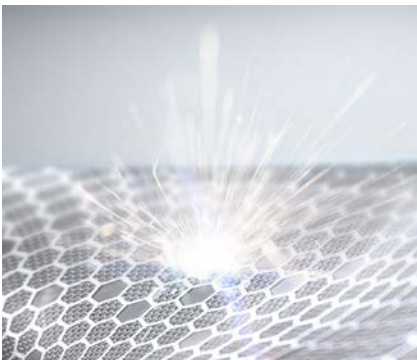

Sensation line

The AgieCharmilles LASER S series is a highly efficient, fully digital, all-in-one Laser texturing solution conceived to help you achieve the desired texturing quality without compromising your productivity. Use the full potential of GF Machining Solutions' latest-generation Laser texturing innovation to stay ahead of your competitors.

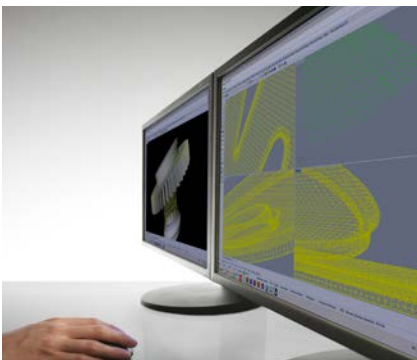

Software

Our fully digital five-axis texturing and engraving process uses smart mapping solutions coupled with Smartpatch capabilities. As the most powerful software solutions package on the market, this all-in-one dedicated software suite enables Laser blasting, texturing and machining processes. Master your job from the preparation phase and graphic design all the way through to transition-free patching and UV mapping for applying texture and 3D simulation.



GF Machining Solutions Academy

Knowledge is key in manufacturing today, as topics, capabilities and training itself are changing. The academy facilitates the knowledge transfer that is key to customers exploiting the full capabilities of their Laser machines with "Learn to operate" modules such as LASER-Starter and LASER-Master and "Maximize performance" modules to exploit 100% of your machine's capabilities and deliver the best results.



Suitable for machining a wide range of precise and repetitive parts

Thanks to its compactness and innovative mechanical concept offering an exceptional rigidity, the AgieCharmilles LASER S 2500 U can easily machine parts of large dimensions. Thoughtfully determined cooling zones combined with the linear motor and torque allow a high dynamic while ensuring thermal stability throughout the entire machining process.

	Standard machine head	Advanced machine head	Laser head Thermostabilization	Body Thermostabilization	High-speed 3D scan	Pack Laser source 30 WFP	Pack Laser source 50 WFP	Pack Laser source 100 WFP	Pack Laser source 150 WFP	Twin Laser	Lens M39 F series	Lens M85 FS series	Automation kit and doors	Dust exhauster	Roll engraving adaptation	Smartscan/ Smartpatch capabilities
LASER P series																
600 U	+					+	+	+			+		+	+	+	+
1000 U	+					+	+	+			+		+	+	+	+
1200 U	+							+			+			+		+
LASER S series																
1000 U		+	+		+	+	+	+		+		+	+	+	+	+
1200 U		+	+		+			+		+		+		+		+
2500 U		+	+	+	+			+	+	+		+		+		+



LASER S series

Execute your latest innovations at the speed of the manufacturing world

Improve your texturing performance to achieve unparalleled texturing productivity without compromising your quality. The new LASER S series was conceived as the new market reference in terms of quality output to help you meet new market demands. Quality is your target. That's why the LASER S series offers extreme machining speed, allowing designers to execute their designs while controlling the cost per part. A new technological era starts right here, right now.

The foundation of your success

Execute your latest innovations in texture design with quality and productivity thanks to the LASER S series' robust mechanical structure and brushless motors. Machine with confidence that you will achieve perfect results from a solution based on our legacy as a technology pioneer.

Driving operator efficiency

GF Machining Solutions' customer-centric approach is proven by the LASER S series' LASER HMI, so your operator achieves best efficiency along with optimal comfort, productivity, ease of use and ability to focus on the task at hand. The control panel is adjustable to accommodate the operator's height for greatest efficiency, and the ergonomic remote control is standard.

Keep an eye on your machining process

This solution's large windows allow your operators to monitor the texturing operation with comfort and safety through protective Class 4 windows. Admire the full efficiency delivered by the LASER S series right now.



For your comfort and a clean environment

The AgieCharmilles LASER S series provides you with a clean working environment while increasing operator safety and comfort—all while helping you maximize your potential with an optimal dust extraction system.

rConnect brings smart manufacturing to your workshop

GF Machining Solutions' rConnect digital services platform empowers you to increase your manufacturing productivity. Our latest modules are indispensable tools for your daily business. Count on a secure connection based on the latest technology—certified by TÜViT.



Revolutionary surface texturing

Push the texturing performance of the LASER S to 100% of its capabilities with our innovative Smartpatch and 3D Smartscan software elements. The software maximizes the LASER S series' performance and helps you achieve extraordinary texturing results.



All-in-one solution
Laser blasting,
structuring, engraving,
machining, texturing
and marking.



Patented Smartpatch
Take your quality
and machining time
optimization to new
levels.



Smartscan 3D
Count on Smartscan
to optimize every patch
you machine.



Bring your vision to life
with Laser texturing.

Preparing the digital file

Take your designs to a new level of innovation

Designers, can you imagine a technology that combines total design freedom and complete control of your texturing costs to help you get your ideas to market? That is the reality today with GF Machining Solutions' AgieCharmilles LASER S series. It brings together all of the prerequisites to satisfy your vision of making your product a reality.

Fully digitized process with an all-in-one solution

GF Machining Solutions' fully digital process for five-axis texturing and engraving uses smart mapping solutions coupled with Smartpatch capabilities—the most powerful Laser machining software solutions package on the market. This all-in-one dedicated software suite enables Laser blasting, texturing and machining processes to drive your success. It allows you to master your job from the preparation phase and graphic design all the way through to transition-free patching and UV mapping for applying texture and 3D simulation. Experience greater application flexibility and machining results aligned with your expectations with our complete toolbox ready to perfectly answer your specific application requirements.

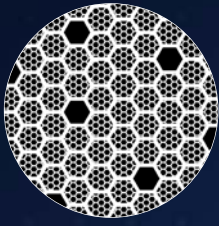

Texture bitmap

Design geometrical patterns up to 16-bit gray scale image with confidence that your idea will be respected.

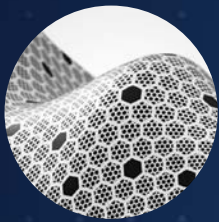
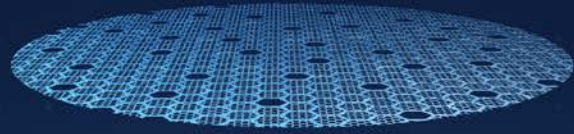

Mapping

The 3D mapping of your texture is perfectly executed, taking into account the orientation and size of each element of your idea.

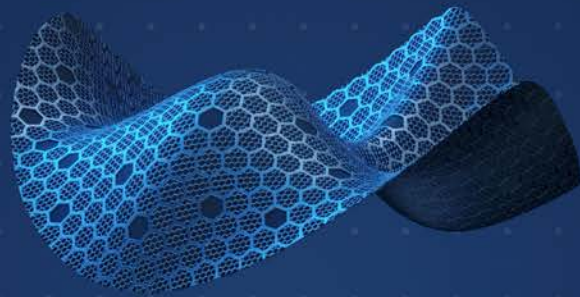

Getting started with a digital file

Begin with the 3D model of your part to define the desired texture and execute a qualitative GF Machining Solutions Laser operation.

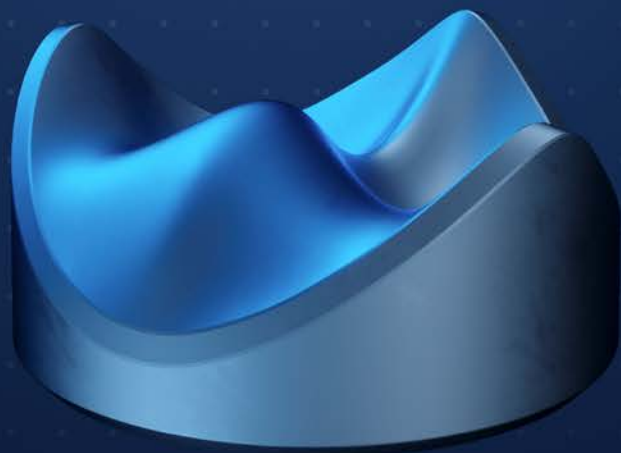

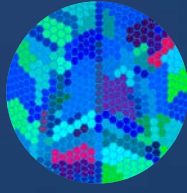

Smartpatch thinks for you
Each five-axis movement is calculated to most efficiently deliver the best shape of your texture while optimizing machining time—the result of a great combination: Smartpatch and the LASER S.

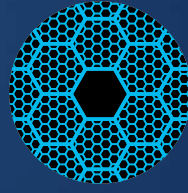

Perfect respect of your texture shape
By avoiding unnecessary machine movement, Smartpatch and the LASER S guarantee the best shape accuracy of your texture.

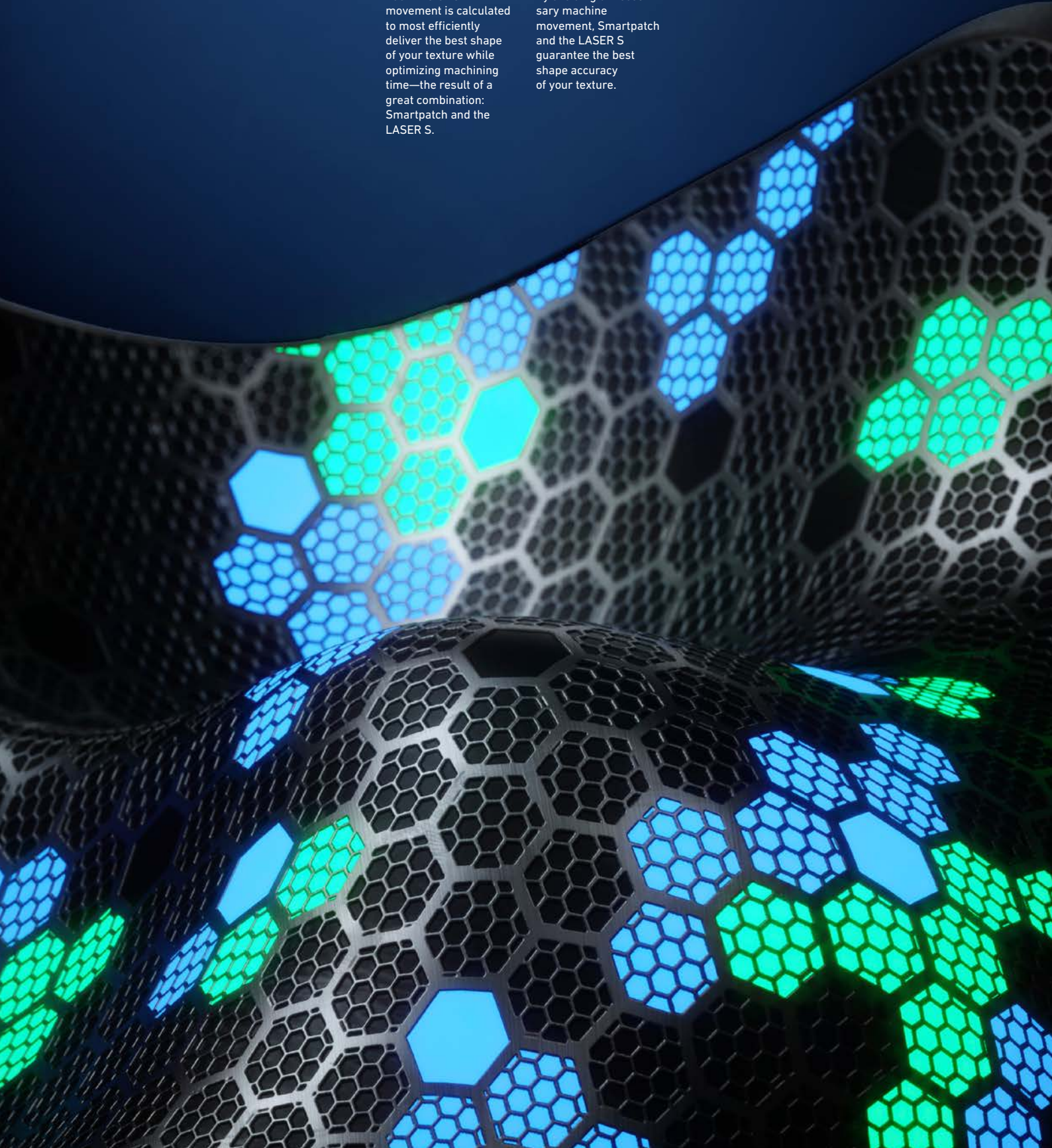

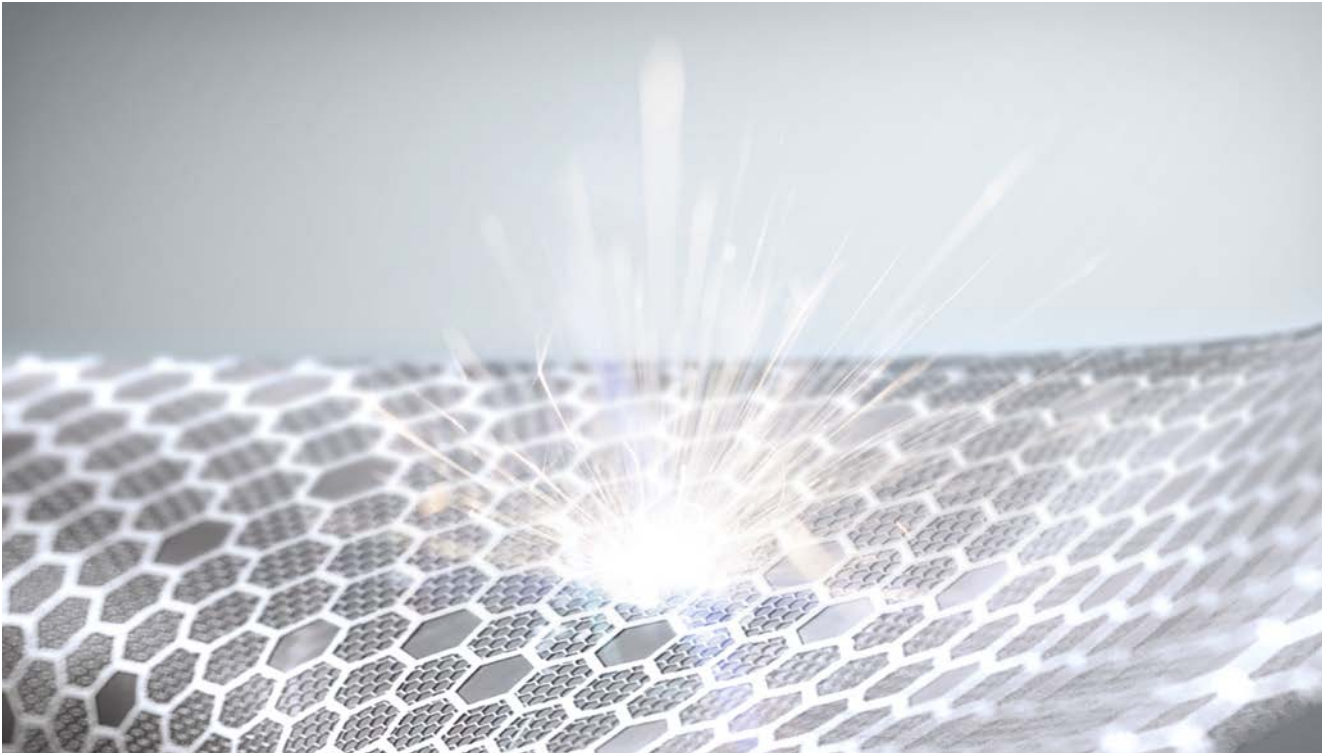

Get the best from our solution
 Discover the efficiency of Smartpatch and push your quality and productivity to the max with the LASER S series.

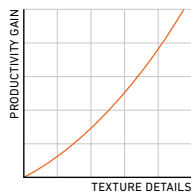

Smartscan
 While Smartpatch boosts machining strategies, Smartscan ensures that every patch is executed with maximum efficiency and uncompromising quality.

Smartpatch at its maximum capacity advances both quality and productivity

To date, even the most advanced Laser texturing solutions have forced manufacturers to make some sacrifices in terms of either quality or productivity. That's because most existing laser texturing machines randomly apply textures to the workpiece surface, working from one area to the next to remove material in patches. Without a smart patching solution, productivity and quality are compromised due to inefficient texturing strategies and texturing errors induced by the movement of the laser head. Smartpatch boosts both quality and productivity for the market's most challenging textures. Coupled with the AgieCharmilles LASER S hardware capabilities, performance is even further improved, so you experience the best five-axis Laser texturing solution on the market.

Driving your hardware with intelligence and efficiency

We drive the productivity of your hardware with intelligence and efficiency. Timing is always a key to reducing cost per part, and our AgieCharmilles LASER S series is optimized to deliver full efficiency for every patch machined, thanks to Smartscan, a new creation by GF Machining Solutions.

The multi-process solution to drive your success

In today's fast-moving market, you never know what type of machining job you will confront tomorrow. That's why it is becoming a must to have a machine that can be quickly adapted to your application, as well as easy access to two interchangeable Laser sources, and our Flexipulse capabilities to shape or mark your text or work on the surface—all on the same machine.

Laser texturing

Extend your design possibilities and quality compared to chemical etching processes while achieving faster time to market. The LASER S is up to 50% faster, depending on the application, at executing challenging geometrical textures. Experience a new era in Laser texturing.

Laser engraving and marking

Simplify complex manufacturing processes to save time while achieving higher quality. LASER technology makes it easy for you to tackle complex jobs and helps you to increase surface quality while speeding up your operation.

Laser blasting and structuring

Higher flexibility, precision and ease of use compared to sandblasting boost quality and application possibilities while optimizing lead time. The LASER S now executes such operations up to 50% faster than was previously possible.

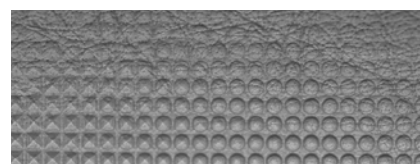

Laser texturing

Whether you need a geometrical or a natural pattern—or a combination of the two—the LASER S series represents the magic of digitally manufacturing your products.



Laser engraving and marking

Engrave text in three or five axes and machine shapes as well, all in a single setup.

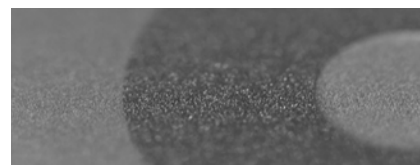

Laser blasting

Achieve perfect blasting homogeneity, reduce risks of mistakes and prepare for the future need for functional surfaces. Laser blasting guarantees homogeneous and reproducible results, without risk and without any abrasive chemical means.

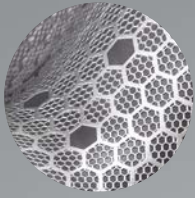

Laser texturing
40% machining time reduction with Smartpatch



Laser engraving
Surface finish reduced to Ra 1.0 µm



Laser 3D marking
Now 40% faster

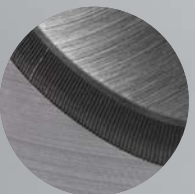

Laser blasting
Now 50% faster



* Results compared to solutions without high-speed 3D scanning feature



Larger marking field
Reduce machine movements to boost your Laser operations' efficiency and quality.



Two nano Laser sources
Manufacturing agility is the challenge; the LASER S is the solution. Be ready to switch from one Laser to another to execute your specific daily jobs.



Flexipulse
Achieve higher quality: Fine-tune your tools and adapt your Laser parameters down to the finest detail.



High-speed scanning system
Reduce your machining time and increase your machining productivity with the faster 3D scanning enabled by the high-speed scanning system embedded in our unique Laser solution.



Mechanical innovative concept emphasizing productivity and quality

Thanks to specifically high displacement dynamics, the AgieCharmilles LASER S 2500 U offers increased productivity during high volume machining. More and more, the technical solutions provided by the Laser technology allow to address substantial workpiece sizes. With supercharged dynamics, the machining times are greatly reduced but the exceptional quality of ablation is maintained.

* Picture made at GF Machining Solutions' Geneva R&D center

Innovations at a controlled cost per part

Increased thermostability

We understand your need for quality. Temperature variations are critical when a stable Laser operation is necessary. The new LASER S series' Laser head—built to the highest standards—has thermostabilization to keep the Laser beam spot stable at the desired position throughout your machining operation. Discover the Laser solution that delivers perfect machining quality, even on molds requiring very long machining times.

Larger marking field

Satisfy quality demands in challenging markets like ICT and boost your productivity with our larger marking field. It reduces your machine movement to the minimum. The high-end lenses available with the LASER S series ramp your quality up even further. Your results: Textures are executed faster and at highest precision.

Two Lasers in one solution

You need flexible machining solutions. The LASER S series is the answer, giving you the agility to jump to the next business opportunity. Easily switch from one Laser head to the other to adapt your process to your specific application: Use a 30-watt Flexipulse for demanding high-quality applications and switch to a 50-watt or 100-watt Laser for efficient Laser machining. Advance your manufacturing agility with the solution that's ready for tomorrow's demands—today.

Flexipulse

Optimize the performance details of your Laser source. Our Flexipulse helps you fine-tune your Laser parameters down to the finest Laser source details and get the right quality-to-speed ratio for your application thanks to the unique flexibility offered.

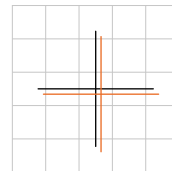

Increased machine stability

The Laser beam position accuracy helps you to get the best machining stability.

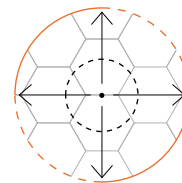

Increased marking field

Get a 40% larger marking field to boost your performance.

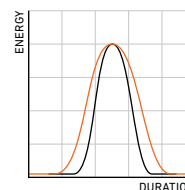

Unique Laser flexibility

Adapt your Laser parameters to match your specific application.

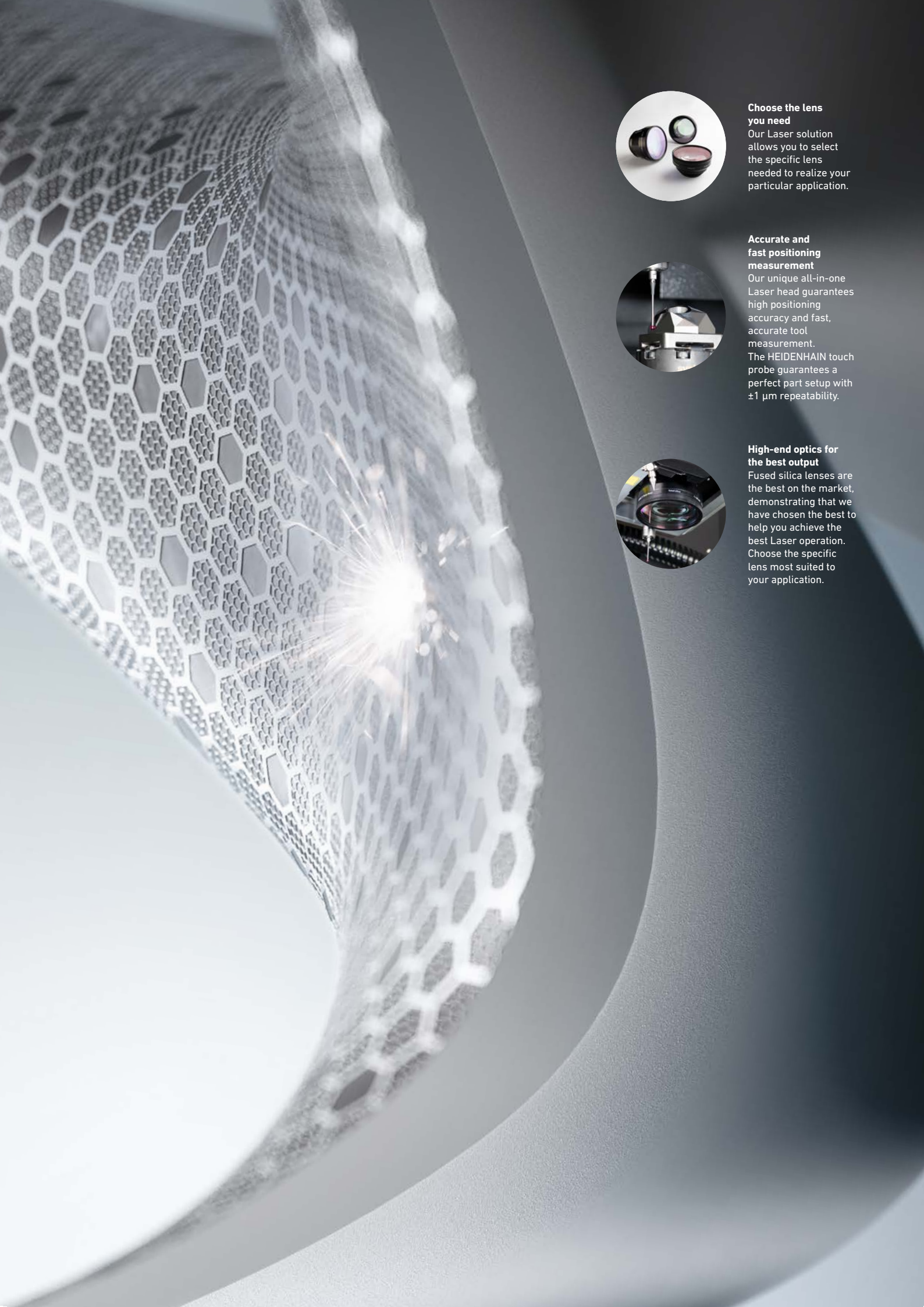

Choose the lens you need
Our Laser solution allows you to select the specific lens needed to realize your particular application.

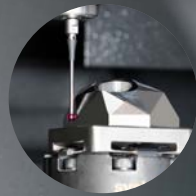

Accurate and fast positioning measurement
Our unique all-in-one Laser head guarantees high positioning accuracy and fast, accurate tool measurement. The HEIDENHAIN touch probe guarantees a perfect part setup with $\pm 1 \mu\text{m}$ repeatability.



High-end optics for the best output
Fused silica lenses are the best on the market, demonstrating that we have chosen the best to help you achieve the best Laser operation. Choose the specific lens most suited to your application.



Max. Z texturing field

60 mm

LASER S 1000/1200 U

100 mm

LASER S 2500 U

Marking field

Up to

140 mm

LASER S 1000/1200 U
with the lens type FS255 mm

Up to

200 mm

LASER S 2500 U
with the lens type FS340 mm



Speed

Boost your lead
time with faster Laser
operations.

High-speed 3D scanning system

Reduce your machining time by up to 50%. With the faster 3D texturing enabled by the high-speed scanning system embedded in our unique Laser solution, you increase your machining productivity to shorten your lead time and reduce your machine return on investment (ROI). Be more efficient, be more clean and be right all the time, thanks to this highly efficient digital solution.

Achieve unique 3D performance

Optimized machining movement guarantees unequalled quality in the shortest time, thanks to our increased marking field, high-speed 3D scanning system, and unique-on-the-market smart programming tools.

Unprecedented efficiency

Execute 3D scanning operations and use the full efficiency of an optical axis compared to a mechanical axis to boost your productivity for the most complex parts. Our LASER S machine offers unique performance of 3D operations thanks to a high-speed 3D scanning system achieving up to 5,500 mm/s scanning speed without compromising your quality.

A unique combination to enable your success

Only GF Machining Solutions can offer you the market's most efficient 3D machining strategies made possible by our unmatched combination of software and hardware.

-50°

135°

Increased
focal distance

5,500 mm/s

Fast scanning mode with FS255 mm

system 3R

720°

A generous
working area

The above figures apply to
LASER S 1000 U and LASER S 1200 U.
For LASER S 2500 U, please refer to page 35.

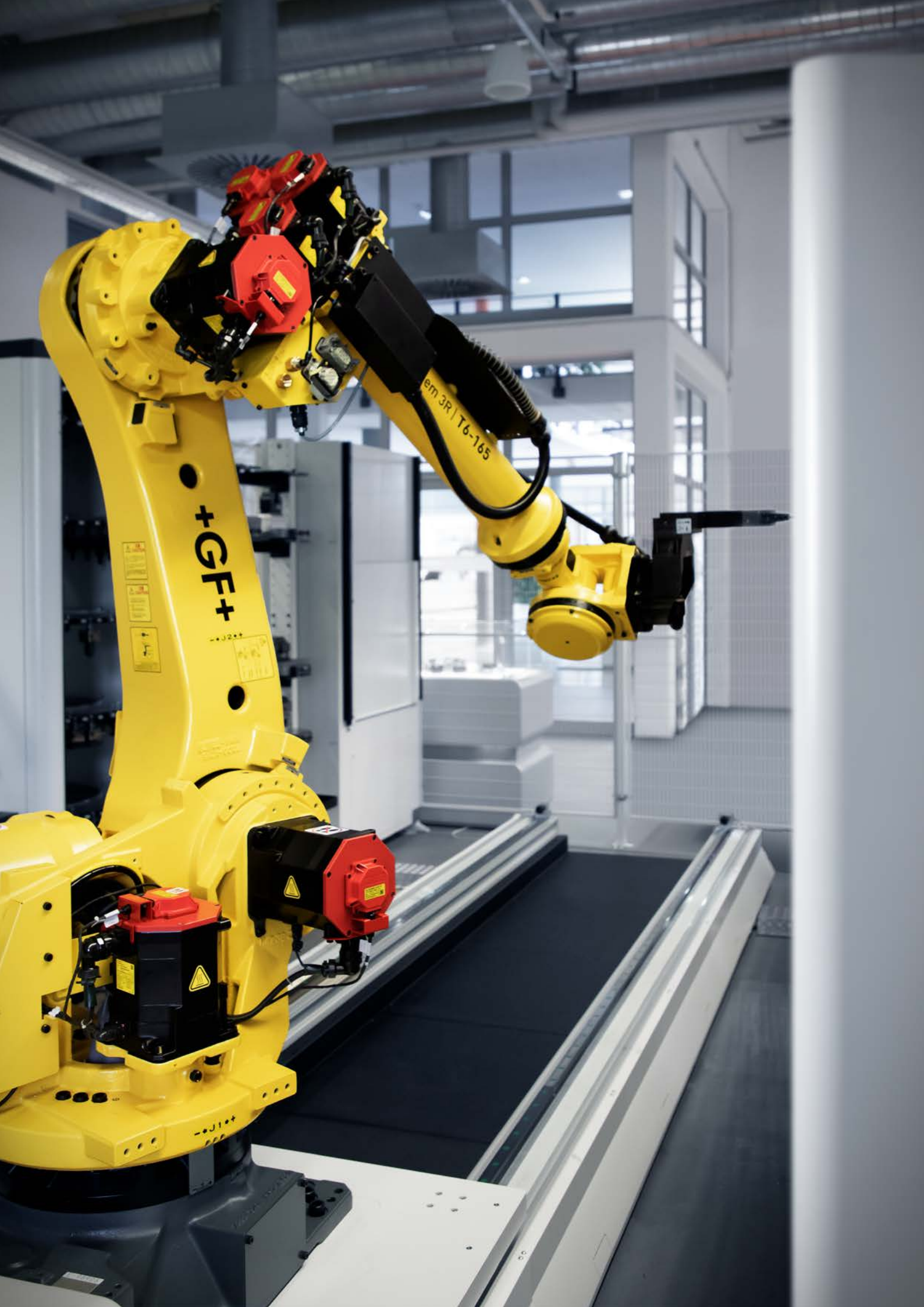

	LASER S 1000 U	LASER S 1200 U	LASER P 600 U	LASER P 1000 U	LASER P 1200 U
Macro			+		
GPS	+	+	+	+	+
MacroMagnum	+		+	+	
Dynafix	+	+		+	+
Delphin		+			+

One partner to optimize your productivity

We deliver a large range of Tooling to match your application and reduce unproductive times on your machine.

Automation solutions

Higher degree of autonomy

Experience always shows that measures to reduce the idle times of your machines are significantly more worthwhile than chasing seconds in the actual machining process. The solution is a stable and exact reference system. This lets you preset away from the machine and then set up the machine with minimum idle time, quickly and precisely with GF Machining Solutions' System 3R Tooling.

Higher productivity while keeping your flexibility

Flexibility, including solutions that can accommodate production changes to match your business and environment, is a key success factor in today's marketplace. To make your machines more flexible in handling workpieces of various sizes, various chuck adapters are available for all of our Tooling systems.

Boost your competitiveness

Automation keeps production going whatever the time of day or day of the week. You achieve shorter lead times, higher productivity and quicker payback of capital invested in machines. With automated operations, production can continue running around the clock, seven days a week. The possibilities are endless.

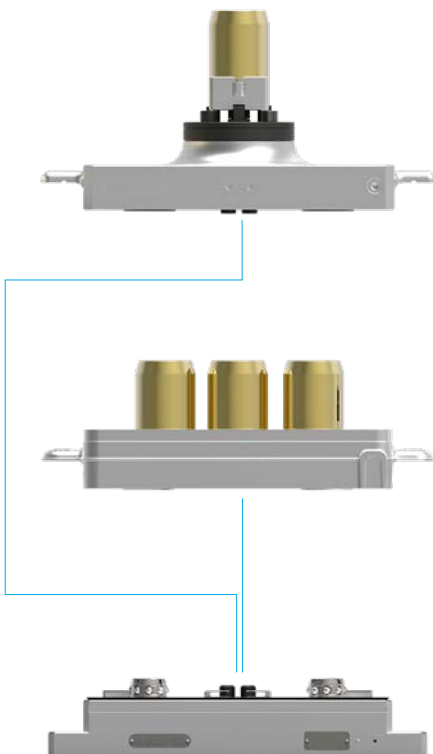

The partner of choice

GF Machining Solutions is the partner of choice to successful tool, mold and die makers in fast-growing market segments like electronic components, ICT and automotive, and to producers of high-value parts for aerospace and aeronautics, the automotive industry, and many other industrial areas.

Active segments

Aerospace	Medical
ICT	Electronics
Automotive	Packaging



Lighting

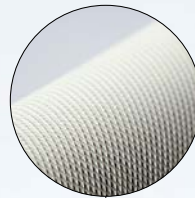

Interiors

Expertise in automotive applications

Trends in the automotive market indicate consumer demands for more personalization, including customization of car exteriors and interiors while geometrical textures in automotive interiors are more and more popular in this sector. Our Laser texturing machines help manufacturers to fulfill these demands, guaranteeing quality, repeatability, and continuity between parts. That's the plus of working with the market reference in mold texturing.

Tire molds



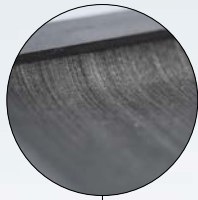

Smartphone covers and accessories



ICT

Fulfill information and communications technology (ICT) industry needs, down to the finest details, with GF Machining Solutions' Laser technology. Profit from the technology that has been globally renowned brands' Laser texturing reference for production of a wide range of end products, from mobile phones to laptops.

Perfect execution of large texturing operations

The AgieCharmilles LASER S series' larger making field and 3D scan capabilities produce perfectly homogeneous textures at the requested quality and in a shorter time to reduce time to market—a proven fact.

Packaging

Productivity, quality, and product differentiation can put you ahead in today's fast-moving global marketplace, especially in the packaging sector, where mold makers and designers are looking for new manufacturing and design possibilities. That's why packaging manufacturers worldwide turn to GF Machining Solutions as their single-source expert partner and provider of success-triggering solutions.

Significantly simplify your operations

The AgieCharmilles LASER S series helps users to reduce their Laser machining operations by up to three times. The LASER S is a revolution for mold makers wishing to go break into the packaging sector.



Blow molds



Closures



Automotive lighting

Achieve perfect Laser blasting operations

The value of automotive lighting molds is high and the manufacturing process can be highly complex, involving several machining technologies and manual processes. Manual processes such as blasting and chemical etching present significant limitations with regard to surface design, the high risk of errors, environmental challenges due to the use of acids, and difficulties in accurately texturing complex 3D shapes.

Substitute your operations for higher value texturing

With GF Machining Solutions' AgieCharmilles Laser texturing solutions, a mold can be textured more quickly in-house without masking, hand polishing or third parties. The technology's versatility means you can play with the grain and meet new functional surface needs, measured with 3D parameters. Via our dedicated Laser Design software, the operator tells the machines the position of the grain, its density, and the organization of the Laser points to be applied to the workpiece surface. The result: many fewer programming hours.

With the LASER S and its large marking field and Smartscan 3D capabilities, homogeneity is perfect and it is executed in record time and with irreproachable surface quality.

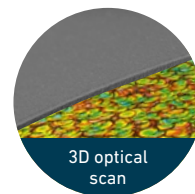

Material
DIN 1.2085

Laser (type/power)
Nano IR 50 W

Machining time reduction

-36%

* vs. without 3D scanning system



Packaging closures

Experience optimal machining operations with a simplified process

Realize more complex shapes and control your operations to make your manufacturing process easier for your operator to manage—all with Laser technology—right now.

Make your processes simple

Get the productivity, quality and product differentiation that are key to staying ahead in today's market. Overcome your business challenges with GF Machining Solutions' complete solution for finishing your mold inserts—such as the closure mold cavity—in a single setup, limiting the risk of human error and opening new design possibilities while reducing the need for additional machining processes. Laser texturing opens new business opportunities, saves you time, and increases your productivity.

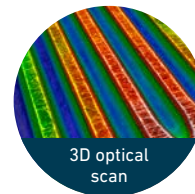

3D optical scan

Material
DIN 1.4301

Laser (type/power)
Nano IR 30 W FP

Machining time reduction
-10%

Surface finish

Ra 1.0 μm



ICT device covers

Fine texturing for laptops and smartphones

Electronics consumers have high expectations for the aesthetics of their laptops and smartphones, and the market is increasingly demanding higher quality. These demands ramp up the pressure on you to produce very fine, perfect textures that are absolutely free of deviations from the original design. Moreover, new 5G smartphones are driving demand for plastic covers, putting your texturing performance to the most extreme tests. For example: engraved molds requiring just one movement of the Laser head. GF Machining Solutions' LASER S meets all of these extreme demands and more to position you for success in this highly competitive sector.

Material
DIN 1.4301

Laser (type/power)
Nano IR 30 W FP

Machining time
3h

New capability for fine textures

Brush pattern detail from ICT insert

Boost your manufacturing efficiency Focus your operators on the essential tasks

Etching processes require time-consuming preparation, such as mold protection, pattern copying, mask application, the manual etching itself and cleaning operations for each layer necessary to achieve your targeted texture depth. With our digital technology, all these tasks can be prepared in advance to optimize your lead time.

Easily master the process and counter the risk of staff turnover

Mold texturers are increasingly difficult to find due to waning interest in the crafts and high staff turnover. This is yet another market challenge. Prepare your operators for the digital future today while readying them to perfectly execute increasingly complex jobs—all while reducing your dependence on manual labor—with Laser technology.

Increase the number of automatic operations

Machine with confidence that you will keep your promises, with our increased automatic machine operations compared to manual operations. We make sure your production is done within the time you promised and with a limited risk of errors.

Chemical Etching process

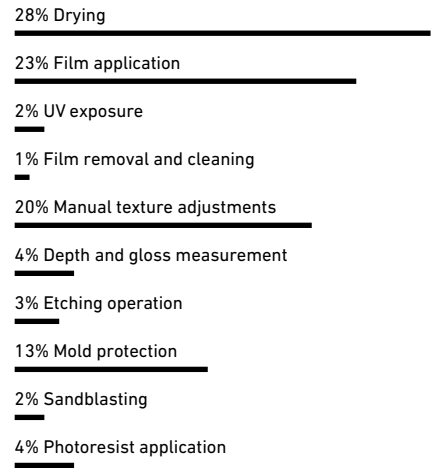

Laser process



Data is a result of a benchmark made in one application and is subject to change from one application to another.

Sustainability

Focus on performance and energy efficiency

Fully digital, reliable and repeatable, Laser texturing technology is by nature more sustainable than the chemical etching processes traditionally used by mold makers. Moreover, the newest generation of AgieCharmilles LASER S series can achieve significant reductions in energy consumption, up to 71% per part. This improvement is made possible thanks to the use of a 3D scanner, more powerful laser sources and from our SmartPatch and SmartScan software packages.



Energy Efficiency Certificate

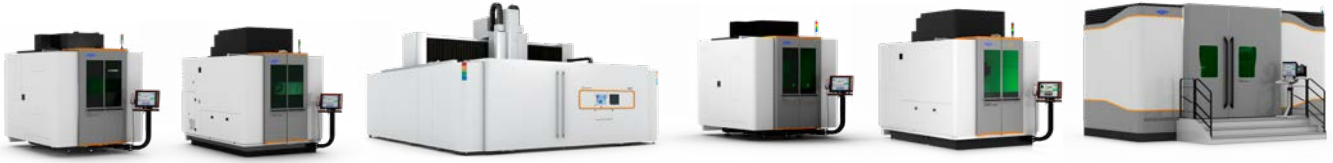

LASER P series (kWh/part)
Laser power: 100 W

LASER S series (kWh/part)
Laser power: 100 W

Energy saving % (per part)
Laser power: 100 W/150 W

Thanks to GF

LASER P 1000 U	23	LASER S 1000 U	16.8	-27% / -37%	1,2/3
LASER P 1200 U	39.1	LASER S 1200 U	25.3	-35% / -44%	1,2
LASER P 4000 U	114	LASER S 2500 U	38.1	-67% / -71%	1,2/3

All measurements were made in accordance with measurement standards as defined in ISO 14955

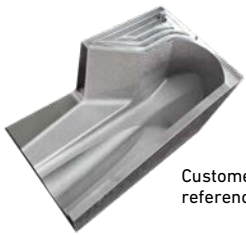

Customer reference part

1 // 3D Scanner

The use of a 3D scanner instead of a 2D scanner allows to reduce the total axis movements.

2 // SmartPatch and SmartScan

These options improve performance and are themselves even more performant with a 3D scanner.

3 // Laser source

A more powerful laser source enhances the quality of engraving and improves the operation's speed.

Over 1 year, the energy saving per part* is equivalent to greenhouse gas and CO₂ emissions from



6,974
smartphones
charged



carbon sequestered by
1
tree seedlings
grown for 10 years



231.7
kilometers driven
by an average
passenger car

Source:
www.epa.gov

* comparison between LASER P 4000 U (100 W) and LASER S 2500 U (150 W)

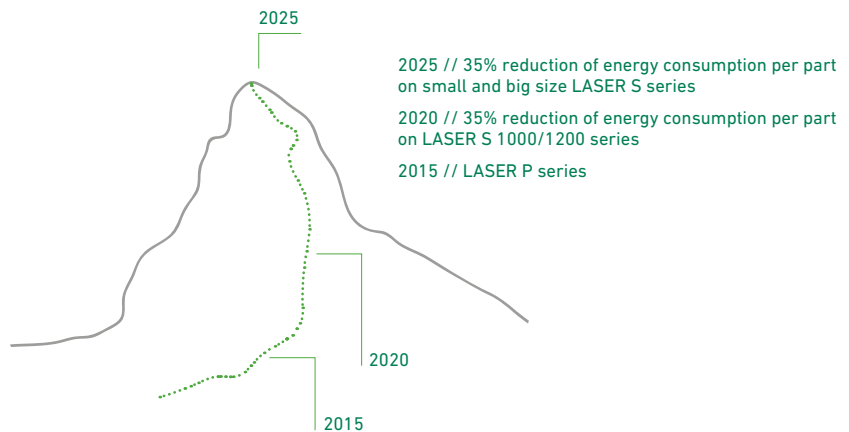



+GF+



AgieCharmilles
LASER S 1000 U



Technical specifications

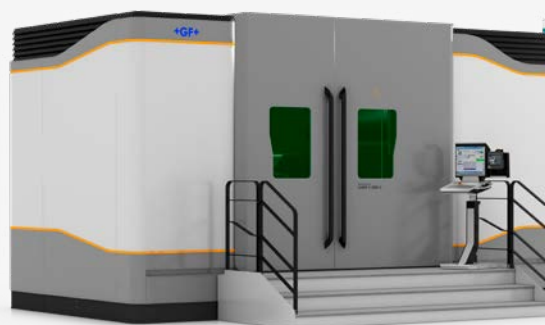
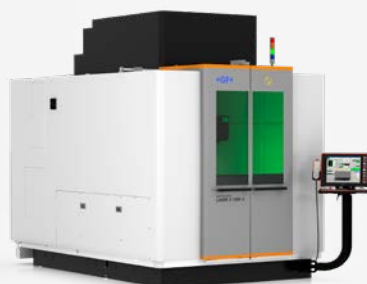
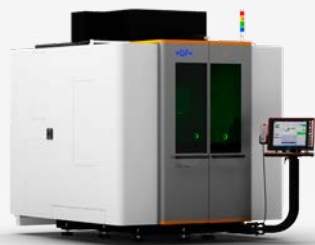

LASER S 1000 U

LASER S 1200 U

LASER S 2500 U

		LASER S 1000 U	LASER S 1200 U	LASER S 2500 U
Machine				
Machine dimensions *	mm	2,240 x 2,678 x 2,645	2,240 x 3,404 x 2,932	6,420 x 3,573 x 3,687
	in	88.2 x 105.4 x 104.1	88.2 x 134 x 115.4	252.8 x 140.7 x 145.2
Space required for installation	mm	3,400 x 4,000	3,500 x 5,000	7,125 x 6,304 x 3,804
	in	133.9 x 157.5	137.8 x 196.9	280.5 x 248.2 x 149.8
Machine weight	kg	6,500	9,170	24,000
	lbs	14,330	19,180	52,911
Focal length	Type	FSTC100 / FS163 / FS255	FSTC100 / FS163 / FS255	FS340
Ytterbium pulsed laser (Flexipulse)	W	30 / 50 / 100	50 / 100	100 / 150
Electrical and pneumatic supply				
Nominal power	kVA	8	8	40
Air pressure	bar	6	6	6
	MPa	0.6	0.6	0.6
Required air output flow	l/min	300	300	150
	gal/min	79.2	79.2	39.6
Axes and table				
X, Y, Z travels	mm	1,000 x 550 x 880	1,200 x 900 x 1,200	2,500 x 2,000 x 1,200
	in	39.4 x 21.7 x 34.6	47.2 x 35.4 x 47.2	98.4 x 78.74 x 47.24
Travel Laser head: A	°	180	180	200 (-50 / +150)
Travel machine table: B	°	720	720	370 (±185)
Table dimensions	mm	380	800	2,600 x 2,200
	in	15	31.5	102.4 x 86.6
Distance floor to table	mm	925	1,030	600
	in	36.4	40.6	23.6
Working area				
Max workpiece dimensions	mm	∅ 660 **	∅ 810 ***	2,700 x 2,300
	in	∅ 26 **	∅ 31.9 ***	106.3 x 90.5
Max workpiece machining height	mm	550 **	850 ***	1,340
	in	21.7 **	33.5 ***	52.8
Max workpiece weight	kg	150	1,700	10,000
	lbs	330	3,748	22,046
Full five-axis dimensions	mm	∅ 510 x 480 **	∅ 560 x 710 ***	∅ 750 x 1,340 ****
	in	∅ 20 x 18.9 **	∅ 22 x 28 ***	∅ 29 x 52.8 ****

* Width x depth x height ** with FS163 *** with FS255 **** with FS340

LASER S 1000 U

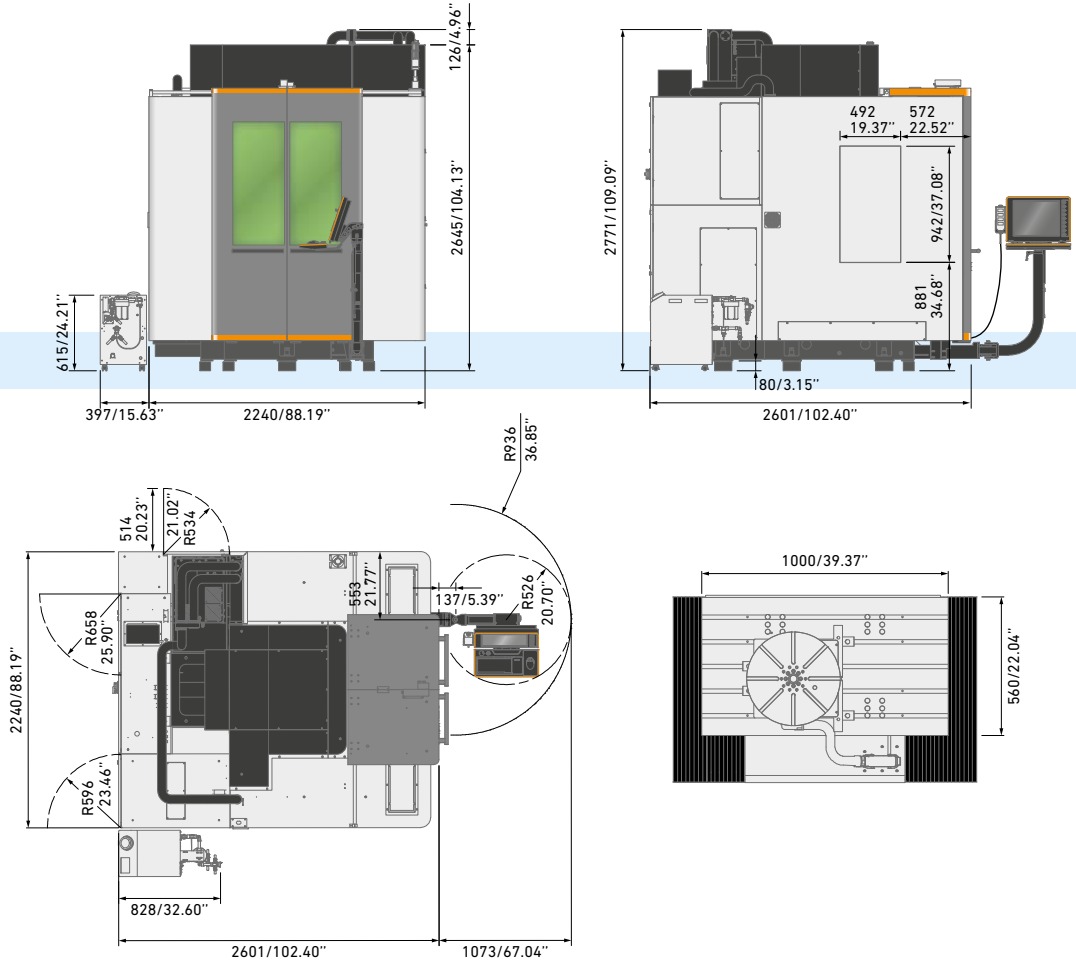

LASER S 1200 U

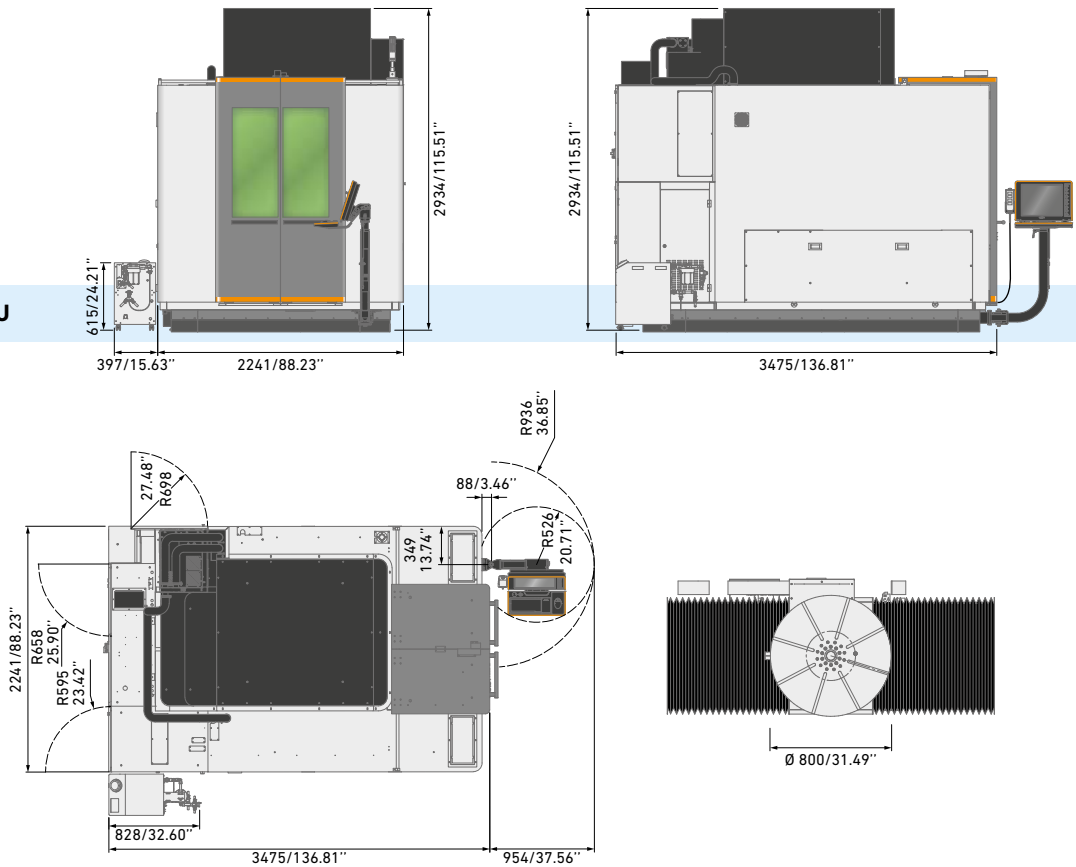

LASER S 2500 U

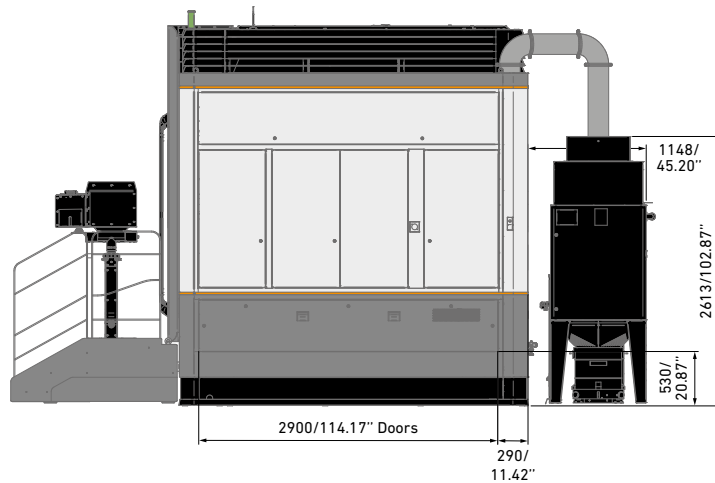
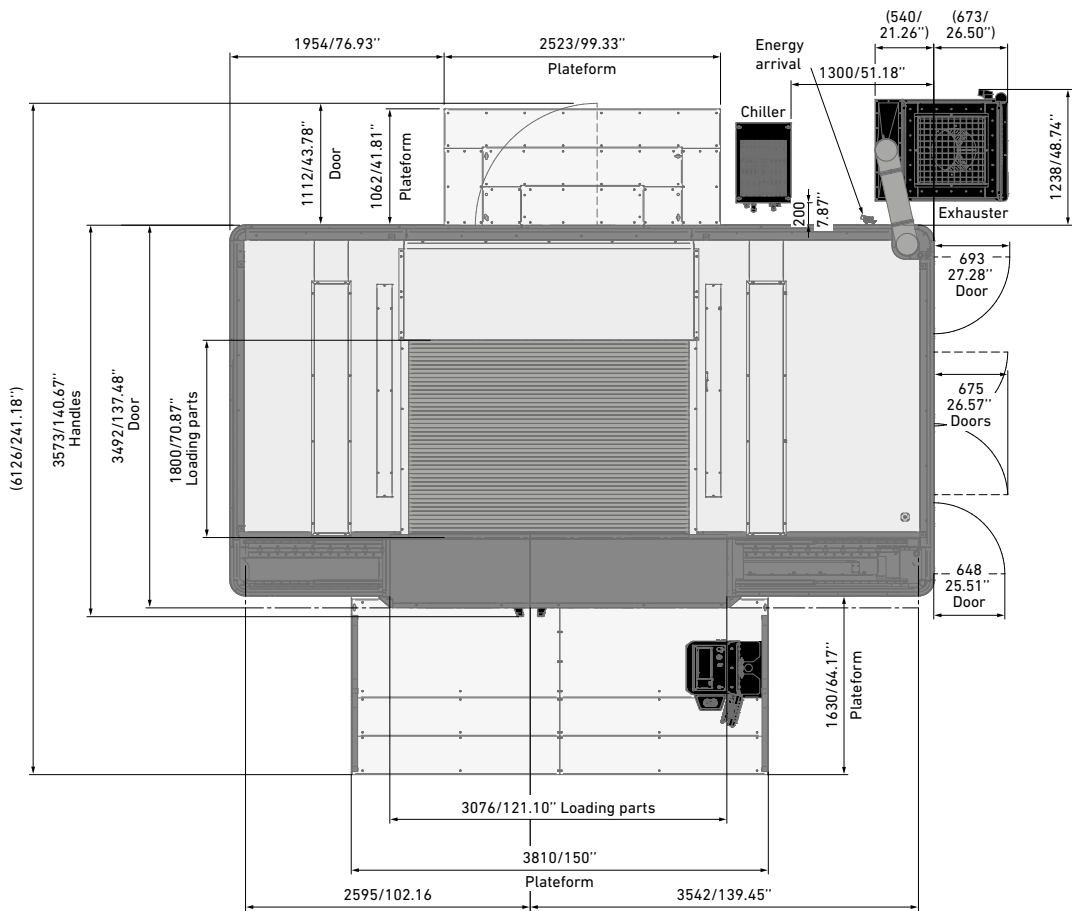
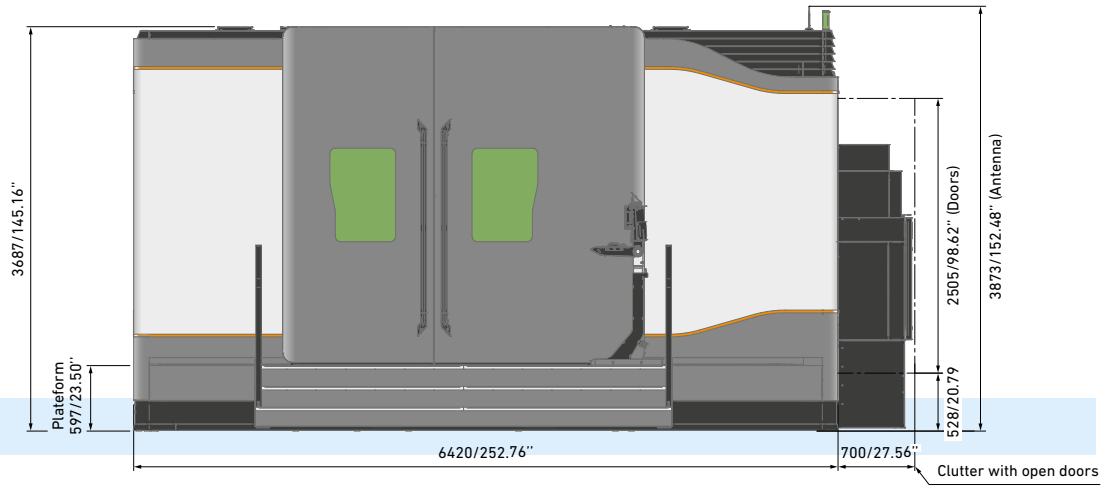

About GF Machining Solutions

Multi-technology solutions provider

Our commitment to you and your specific applications is proven by the value-adding intelligence, productivity and quality delivered by our multi-technology solutions. Your success is our chief motivator. That's why we are continuously advancing our legendary technical expertise. Wherever you are, whatever your market segment and whatever the size of your operation, we have the complete solutions and the customer-centric commitment to accelerate your success—today.

EDM (Electrical Discharge Machining)



Wire-cutting EDM

GF Machining Solutions' wire-cutting EDM is fast, precise and increasingly energy efficient. From ultraprecise machining of miniaturized components down to 0.02 mm to powerful solutions for demanding high-speed machining with respect to surface accuracy, our wire EDM solutions position you for success.

Die-sinking EDM

GF Machining Solutions is revolutionizing die-sinking EDM with features like iGAP technology to dramatically boost machining speed and reduce electrode wear. All of our die-sinking systems offer fast removal and deliver mirror finishes of Ra 0.1 µm (4 µin).

Hole-drilling EDM

GF Machining Solutions' robust hole-drilling EDM solutions enable you to drill holes in electrically conductive materials at a very high speed—and, with a five-axis configuration, at any angle on a workpiece with an inclined surface.

Tooling and Automation



Tooling

Our customers experience complete autonomy while maintaining extreme accuracy, thanks to our highly accurate System 3R reference systems for holding and positioning electrodes and work pieces. All types of machines can easily be linked, which reduces set-up times and enables a seamless transfer of workpieces between different operations.

Automation

Together with System 3R, we also provide scalable and cost-effective Automation solutions for simple, single machine cells or complex, multi-process cells, tailored to your needs.

Milling



Milling

Precision tool and mold manufacturers enjoy a competitive edge with our Mikron MILL S solutions' fast and precise machining. The Mikron MILL P machines achieve above-average productivity thanks to their high performance and Automation. Customers seeking fastest return on investment benefit from the affordable efficiency of our MILL E solutions.

High Performance Airfoil Machining

Our Liechti turnkey solutions enable the highly dynamic manufacturing of precision airfoils. Thanks to the unique performance and our expertise in airfoil machining, you increase productivity by producing at the lowest cost per part.

Spindles

As part of GF Machining Solutions, Step-Tec is engaged in the very first stage of each machining center development project. Compact design combined with excellent thermal and geometric repeatability ensure the perfect integration of this core component into the machine tool.

Software



Digitalization solutions

To drive its digital transformation, GF Machining Solutions acquired symmedia GmbH, a company specialized in software for machine connectivity. Together, we offer a complete range of Industry 4.0 solutions across all industries. The future requires the ability to adapt quickly to continual digital processes. Our intelligent manufacturing offers embedded expertise, optimized production processes, and workshop Automation: solutions for smart and connected machines.

Advanced manufacturing



Laser texturing

Aesthetic and functional texturing is easy and infinitely repeatable with our digitized Laser technology. Even complex 3D geometries, including precision parts, are textured, engraved, microstructured, marked and labeled.

Laser micromachining

GF Machining Solutions offers the industry's most complete line of Laser micromachining platforms optimized for small, high-precision features to meet the increasing need for smaller, smarter parts to support today's leading-edge products.

Laser Additive Manufacturing (AM)

GF Machining Solutions and 3D Systems, a leading global provider of additive manufacturing solutions and the pioneer of 3D printing, have partnered to introduce new metal 3D printing solutions that enable manufacturers to produce complex metal parts more efficiently.

Service + Success



We take you to new heights

Our Success Packs are designed to maximise your return on investment and empower you in your quest for success across all industrial segments. Our subscription packs feature a comprehensive range of services that guarantee the access and support you need to get the most out of your assets today, while preparing for the challenges of tomorrow. Our trusted experts backed by our latest cutting-edge, intelligent Digital Solutions, provide a full range of services.



Switzerland

Biel/Bienne
Losone
Geneva
Flawil
Langnau

www.gfms.com
www.gfms.com/ch

Europe

Germany, Schorndorf
www.gfms.com/de

United Kingdom, Coventry
www.gfms.com/uk

Italy, Agrate Brianza - MI
www.gfms.com/it

Spain, Sant Boi de Llobregat
Barcelona
www.gfms.com/es

France, Palaiseau
www.gfms.com/fr

Poland, Raszyn / Warsaw
www.gfms.com/pl

Czech Republic, Brno
www.gfms.com/cz

Sweden, Vällingby
www.gfms.com/system3r

Turkey, Istanbul
www.gfms.com/tr

Americas

USA
Lincolnshire, IL
Chicago, IL
Holliston, MA
Huntersville, NC
Irvine, CA
Woodridge, IL
www.gfms.com/us

Canada, Mississauga ON
www.gfms.com/us

Mexico, Monterrey NL
www.gfms.com/us

Brazil, São Paulo
www.gfms.com/br

Asia

China
Beijing, Shanghai,
Chengdu, Dongguan,
Hong Kong, Changzhou
www.gfms.com/cn

India, Bangalore
www.gfms.com/sg

Japan
Tokyo, Yokohama
www.gfms.com/jp

Korea, Seoul
www.gfms.com/kr

Malaysia, Petaling Jaya
www.gfms.com/sg

Singapore, Singapore
www.gfms.com/sg

Taiwan
Taipei, Taichung
www.gfms.com/tw

Vietnam, Hanoi
www.gfms.com/sg

At a glance

We enable our customers to run their businesses efficiently and effectively by offering innovative Milling, EDM, Laser, Additive Manufacturing, Spindle, Tooling and Automation solutions. A comprehensive package of services completes our proposition.

www.gfms.com

